

DECEMBER

*My Year*  
**NATURE  
JOURNAL**

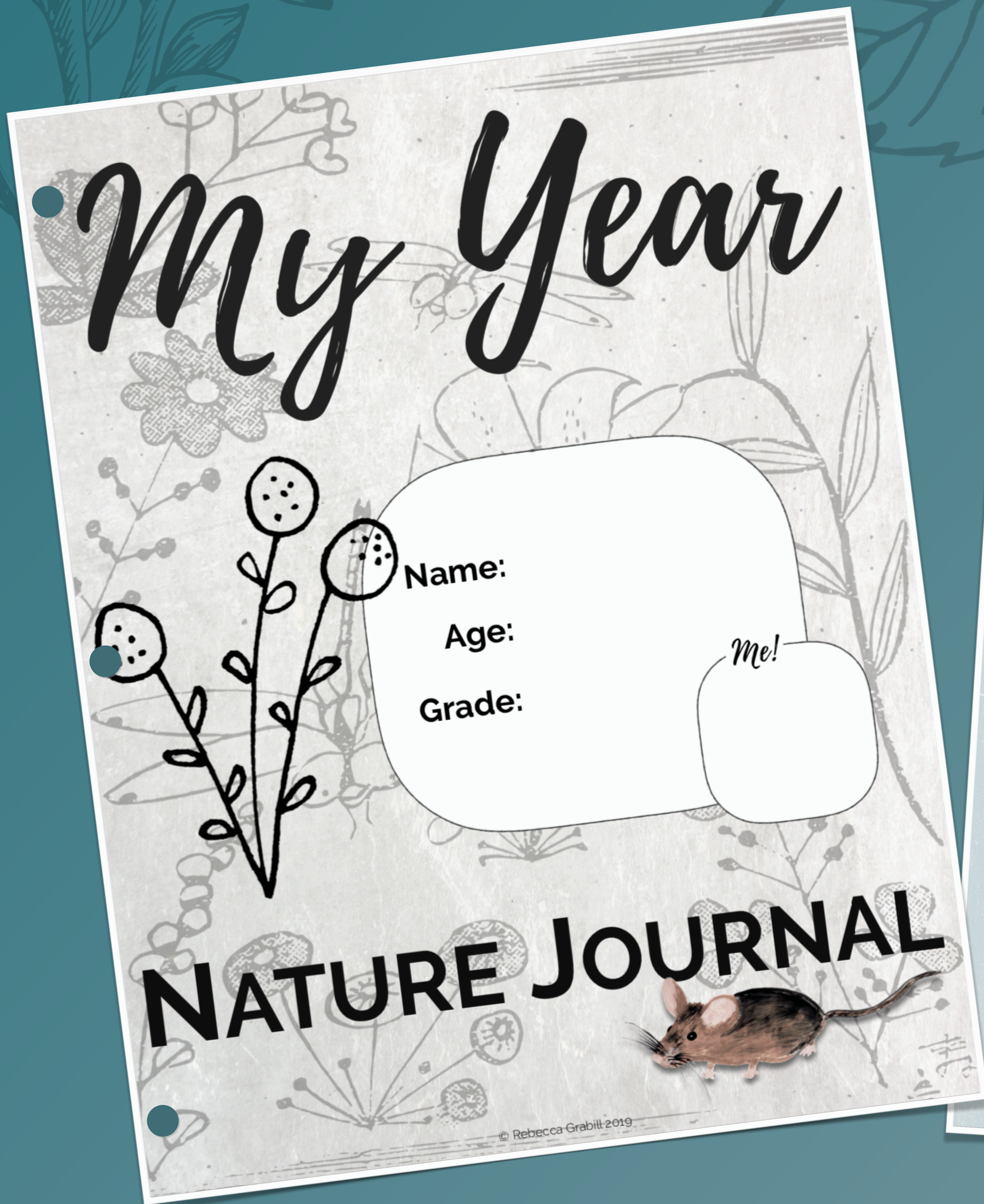

FREE PRINTABLE NATURE STUDY JOURNAL

## **For those downloading in the 2019-2020 school year...**

Each month during the 2019-2020 school year I'll be sharing the next month's printables at [www.rebeccagrabil.com/blog](http://www.rebeccagrabil.com/blog). At the end of the 2020 school year, the FULL *My Year Nature Journal* will be available for download from Teachers Pay Teachers.

# My Year



Name:

Age:

Grade:

*Me!*

# NATURE JOURNAL

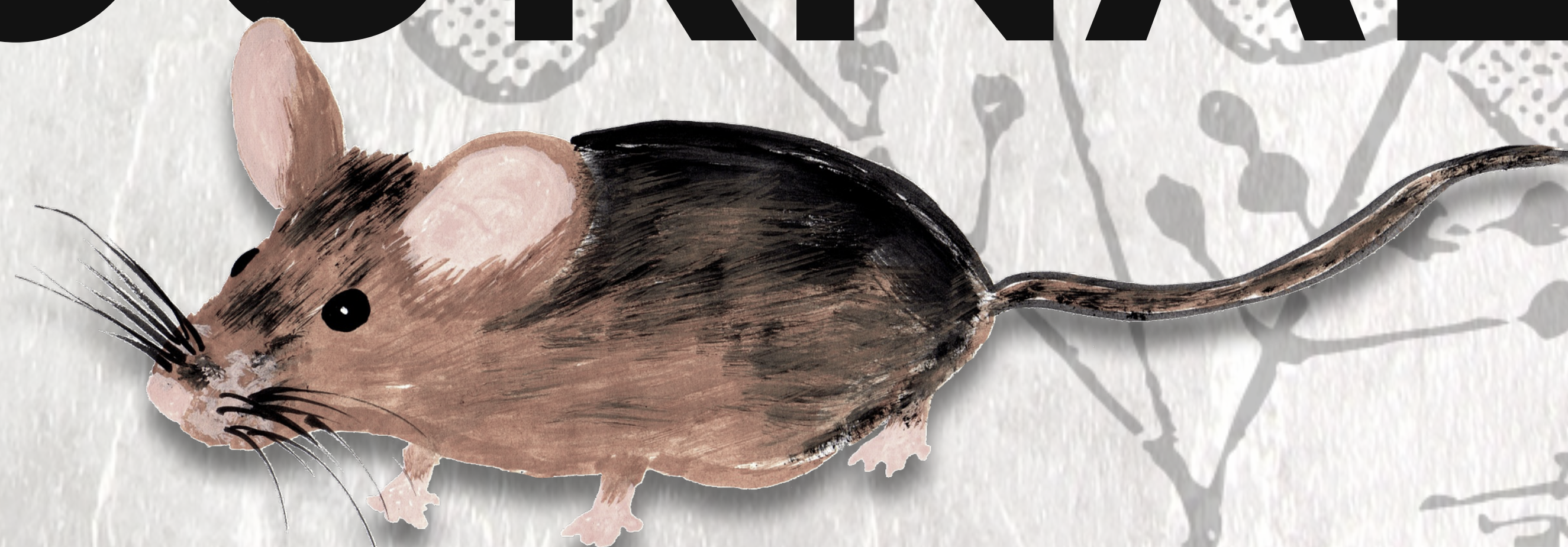

# Lesson Plan

## Notes for Teachers



### December topics:

Constellations

Evergreens

Pine Cones

Gift-giving & Lists



*In December,  
Mama Earth dons her  
winter coat.*

—From *A Year With Mama Earth*

Ah, December. The month of sparkly lights, gift-giving, and overflowing to-do lists. Set some time aside to enjoy nature with this month's journal pages.

You'll be observing, making gifts, collecting treasures, and exploring your winter world!

Find suggestions for each activity page below.

- December: Trace the word *Celebrate* and get your monthly self-portrait dressed for winter! Talk about winter clothing and how we dress for the weather.
- Star Wash: Make a watercolor resist of the starry night. Discussion might include water soluble substances (not wax from crayons!), stars, and the movement of sun and planets.
- Inside a Pine Cone: Collect a seed pod or pinecone and take it apart. Closed pinecones will have seeds within, but open ones have already dropped their seeds. Look at [www.rebeccagrabill.com](http://www.rebeccagrabill.com) for pine cone crafts!
- All the Trees: Explore the differences and similarities between coniferous and deciduous trees and create a Venn Diagram using numbers, drawings, or collected items.
- Treasure Box: The ultimate in upcycling! Collect saved holiday cards and transform them into adorable tiny gift boxes.
- Writer's Corner: Lists are a wonderful starting point for creative writing. Use your lists to inspire more writing like poems or stories!

# December



Sharing with others.

Dress for winter!

*This Month*



Constellations  
Evergreens  
Pine Cones  
Gift-giving & Lists

*In December,  
Mama Earth dons her  
winter coat.*

—From A Year With Mama Earth

Celebrate

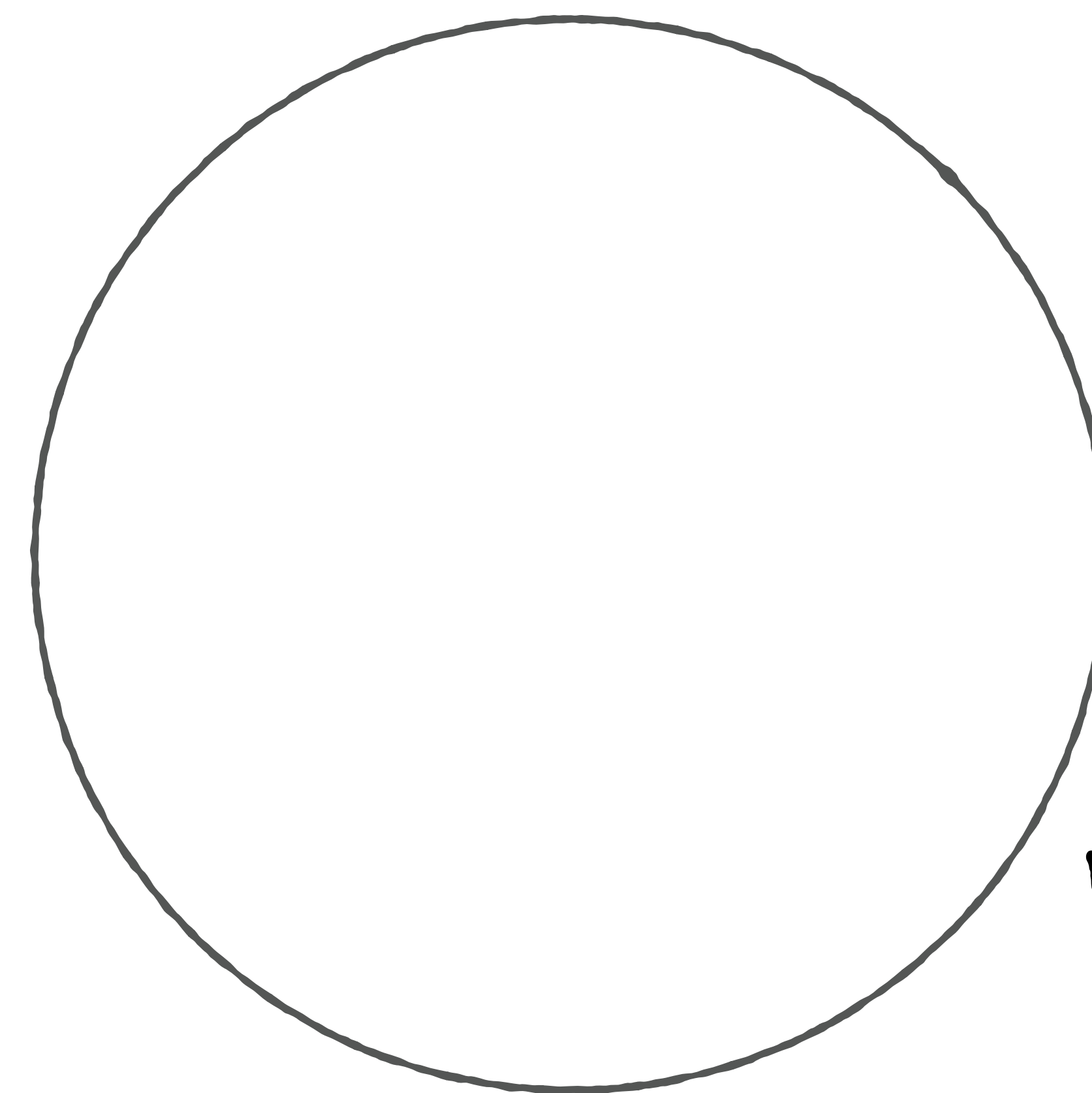

# Star Wash

The Starry Sky



Did you know a group of stars that form a shape are called a constellation? Make your own constellation star wash! 1. Draw stars with CRAYON. Be sure to press hard. 3. Paint over your stars with watercolor paints or color over with marker.

# Inside...

## A Pine Cone



Collect pine cones (or other local seed pods) on your walk. Carefully peel away the outer layers. Draw your pine cone and what you find inside below.

A large, empty rounded rectangular box with a thin black border, intended for a child to draw a pine cone and its internal structure.

# all the Trees



## Deciduous vs. Coniferous

Write the letter in the proper part of the Venn Diagram. Bonus: draw your answers!

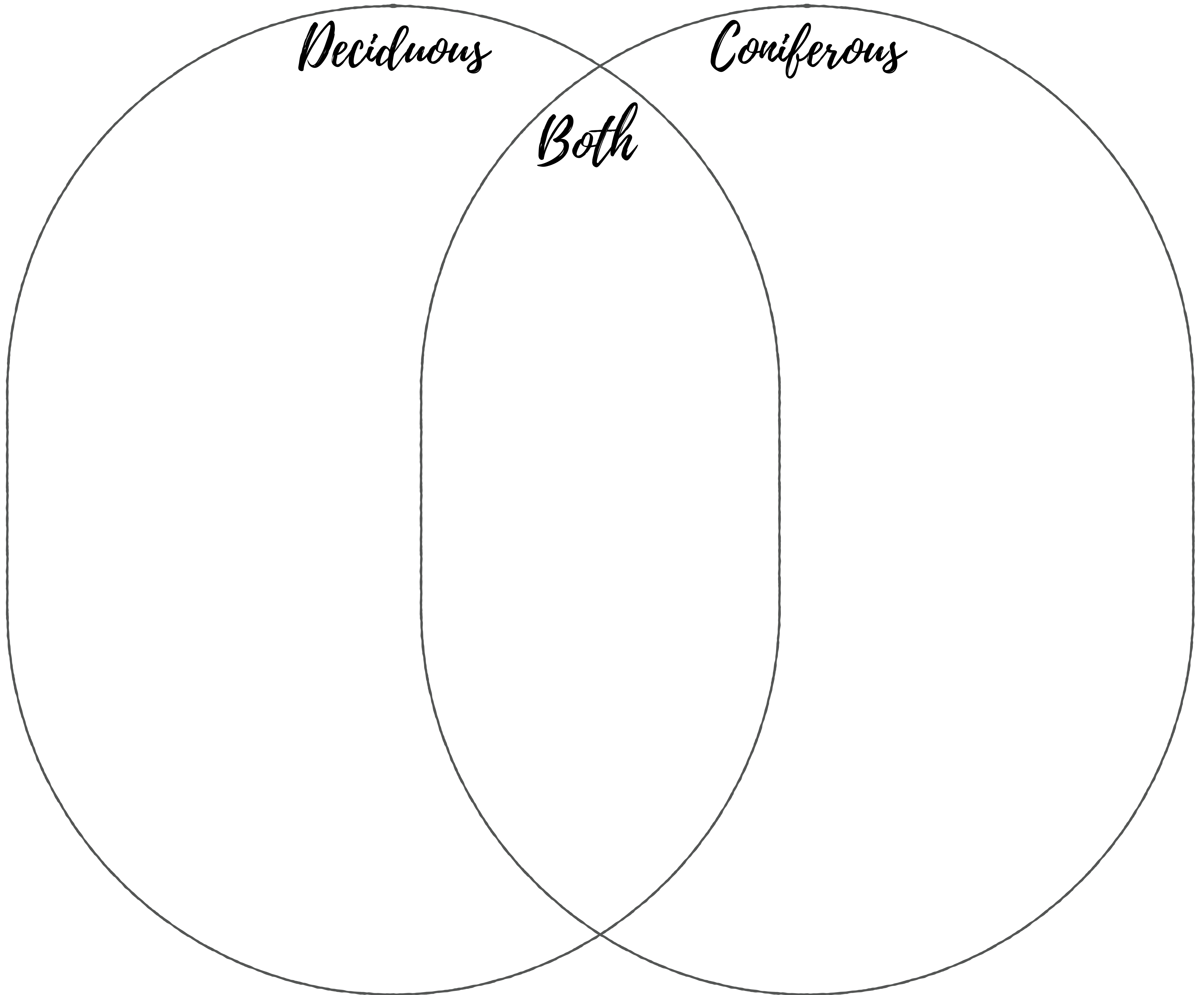

<b>A</b> has leaves	<b>B</b> has needles	<b>C</b> colorful in fall	<b>D</b> drops pinecones
<b>E</b> is beautiful	<b>F</b> has bark	<b>G</b> green in winter	<b>H</b> has seeds



# Treasure Box



## For Holiday Gift-Giving

Make tiny boxes from greeting cards or heavy paper. Fill with delights and gift to all the your favorite people. Who will receive a special gift from you?

*step 1* Cut a square from a greeting card. Tip: fold one corner in to the opposite side to form a square. (If you don't want creases in the lid, measure a square.)



*step 2* Fold each of the corners in to meet in the center. (If you measured your square, find center by connecting the corners with lines on the back side.)

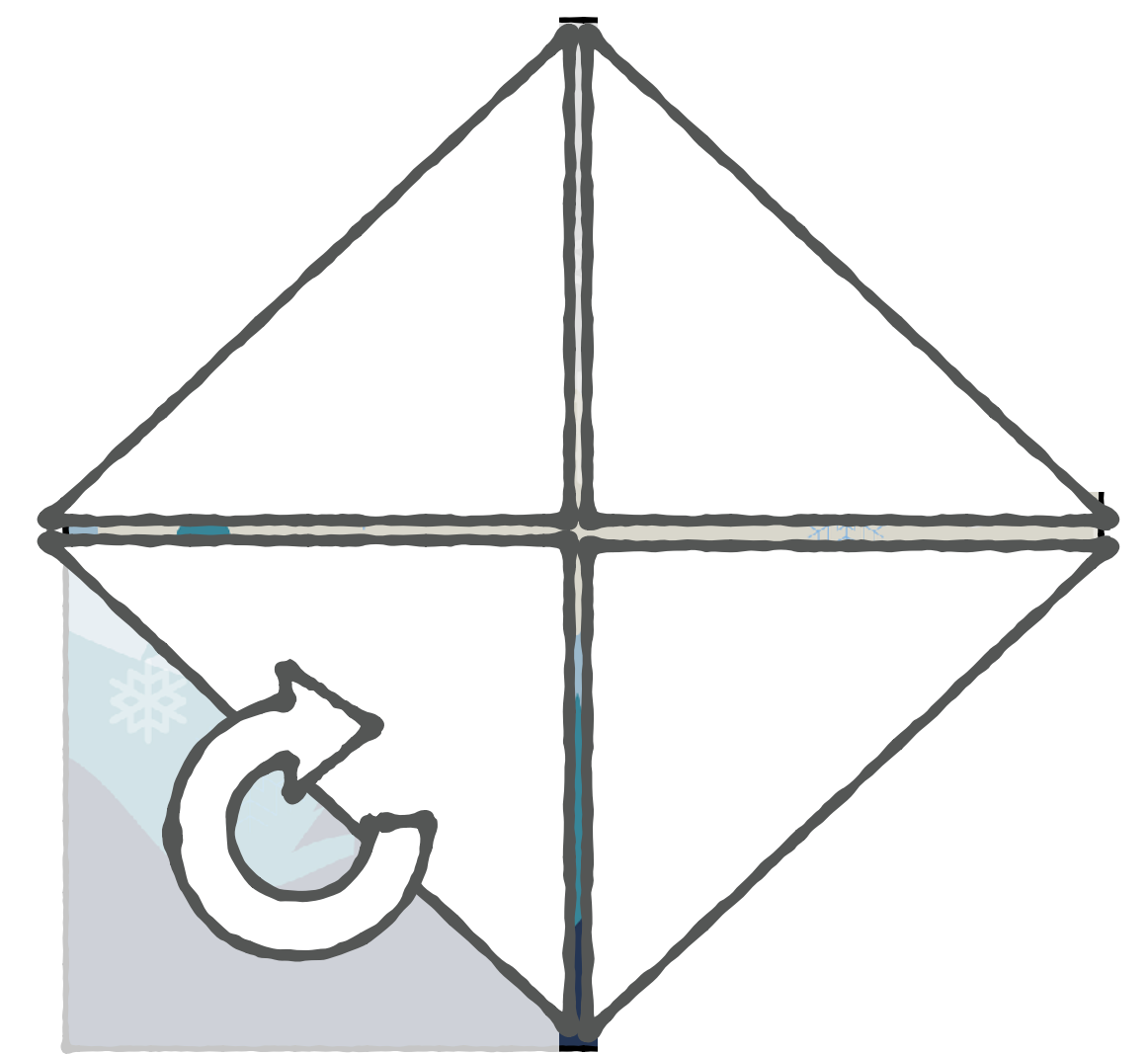

*step 3* Fold the straight edges inward toward the center, unfolding and repeating on the other side.

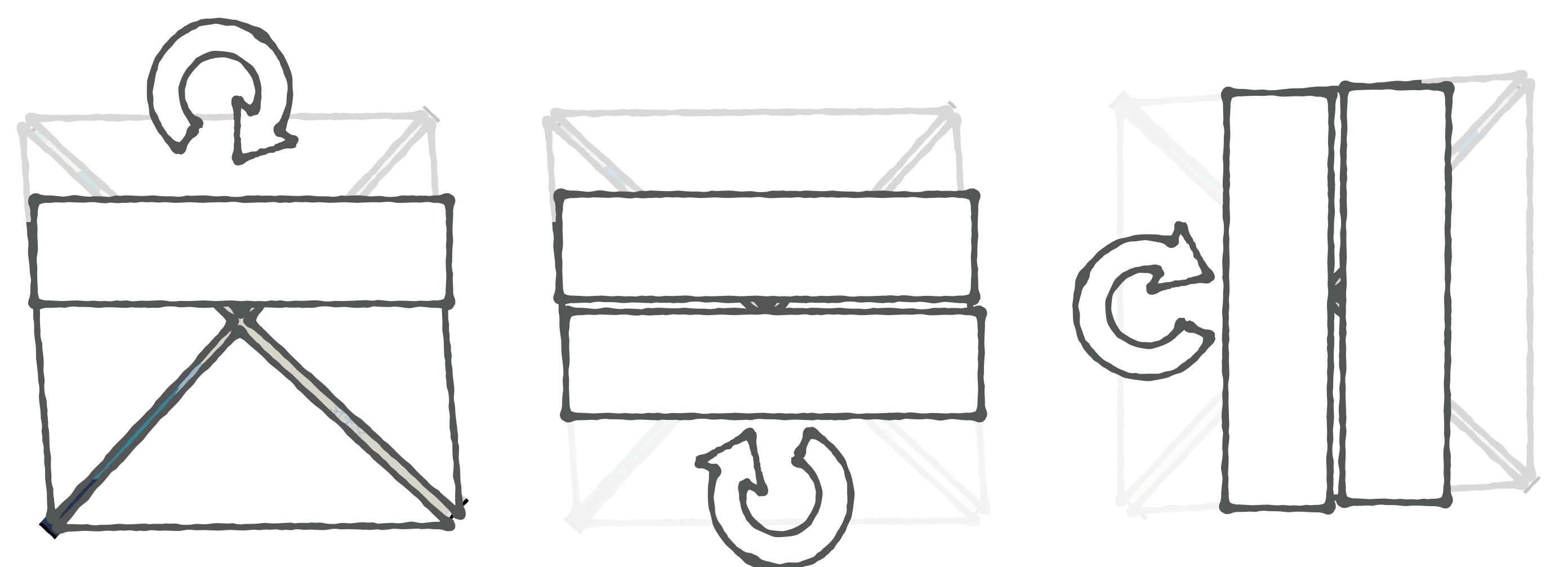

*step 4* Unfold completely. Your paper should look something like this. Mark along the solid lines and snip ONLY to the second fold! Cut and discard the gray triangles.

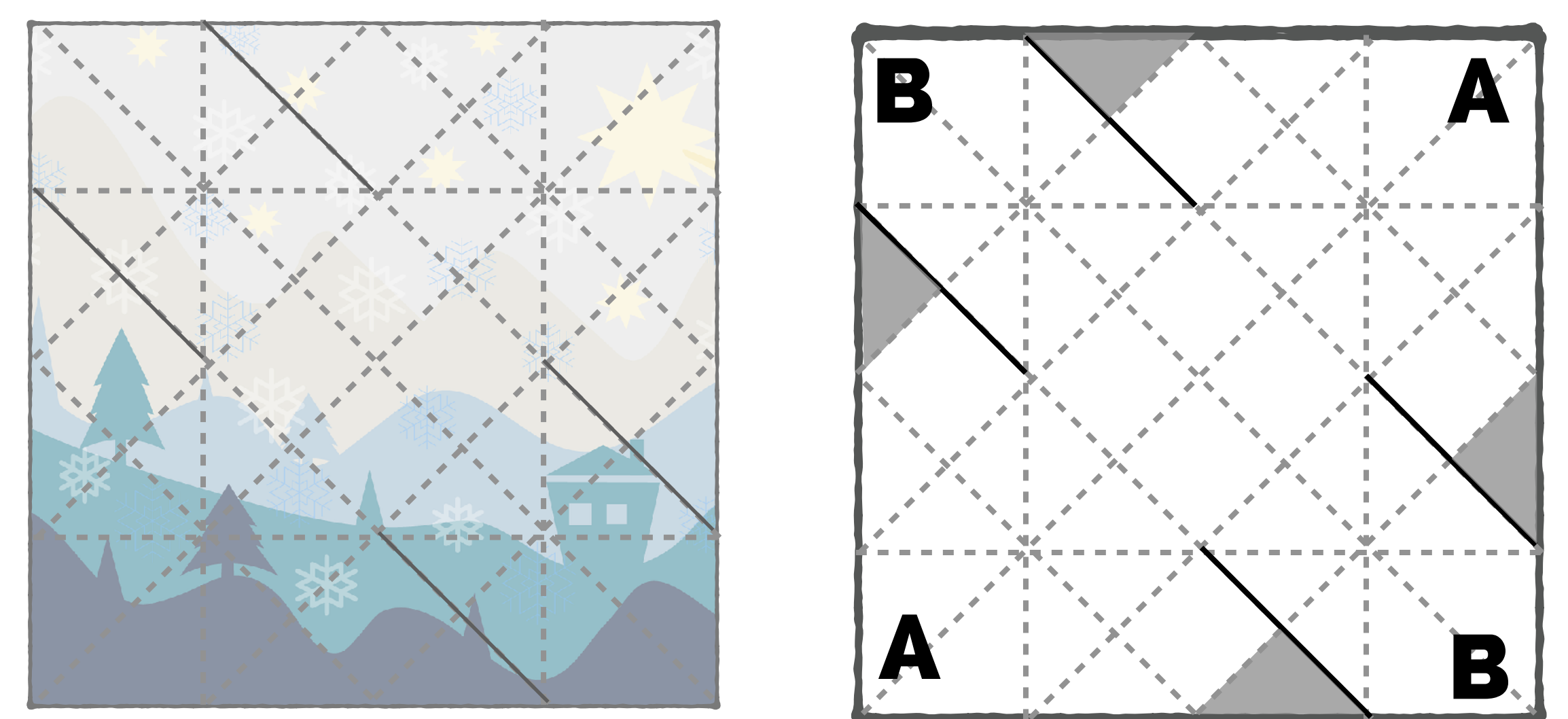

*step 5* 1. Refold corners A to the center. 2. Fold the snipped tabs inward to make the sides of your box. 3. Fold corners B OVER the tabs to make your box!

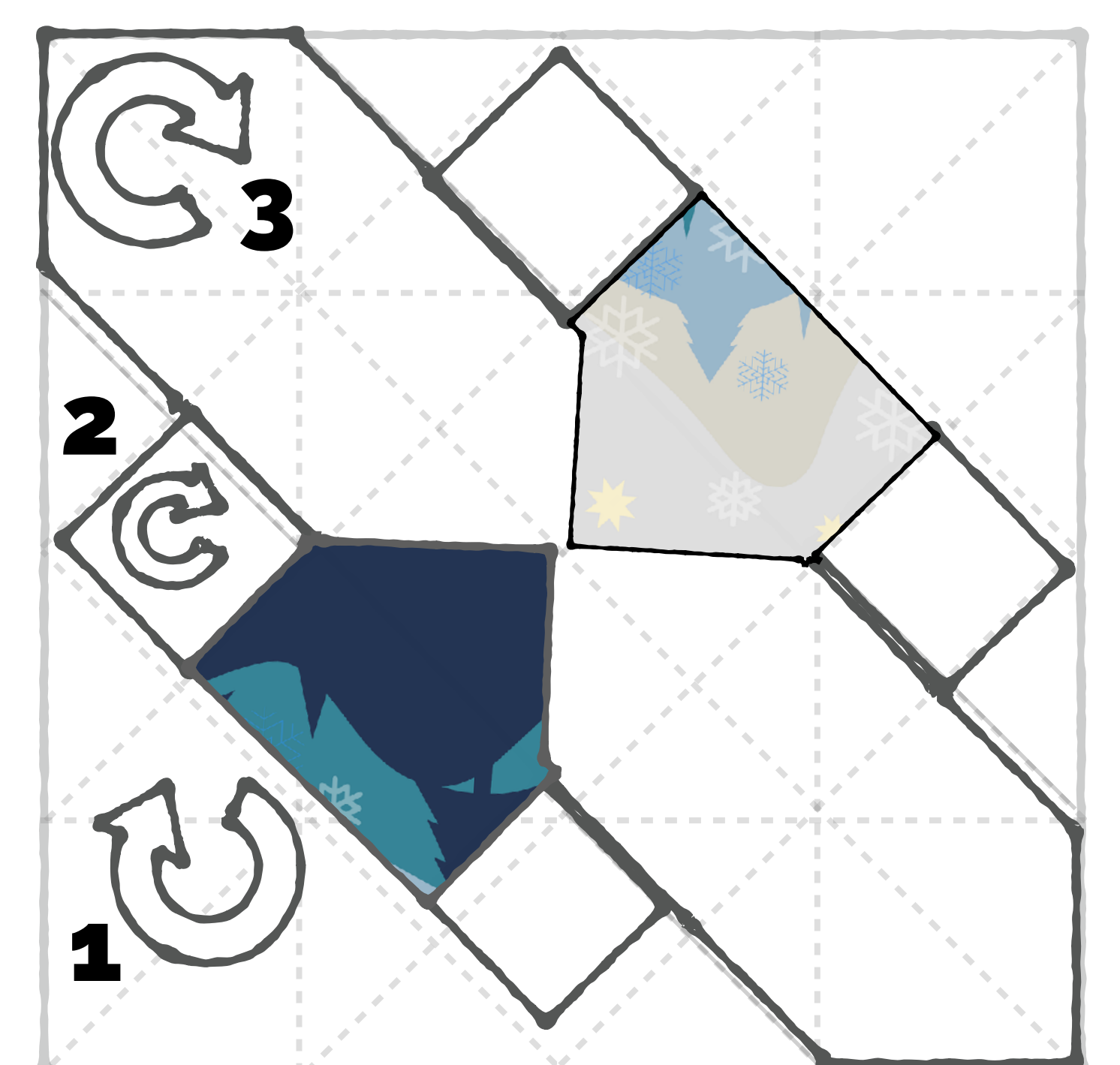

Repeat for the bottom, but make your square approximately 1/4-1/2 inch smaller.



*top*

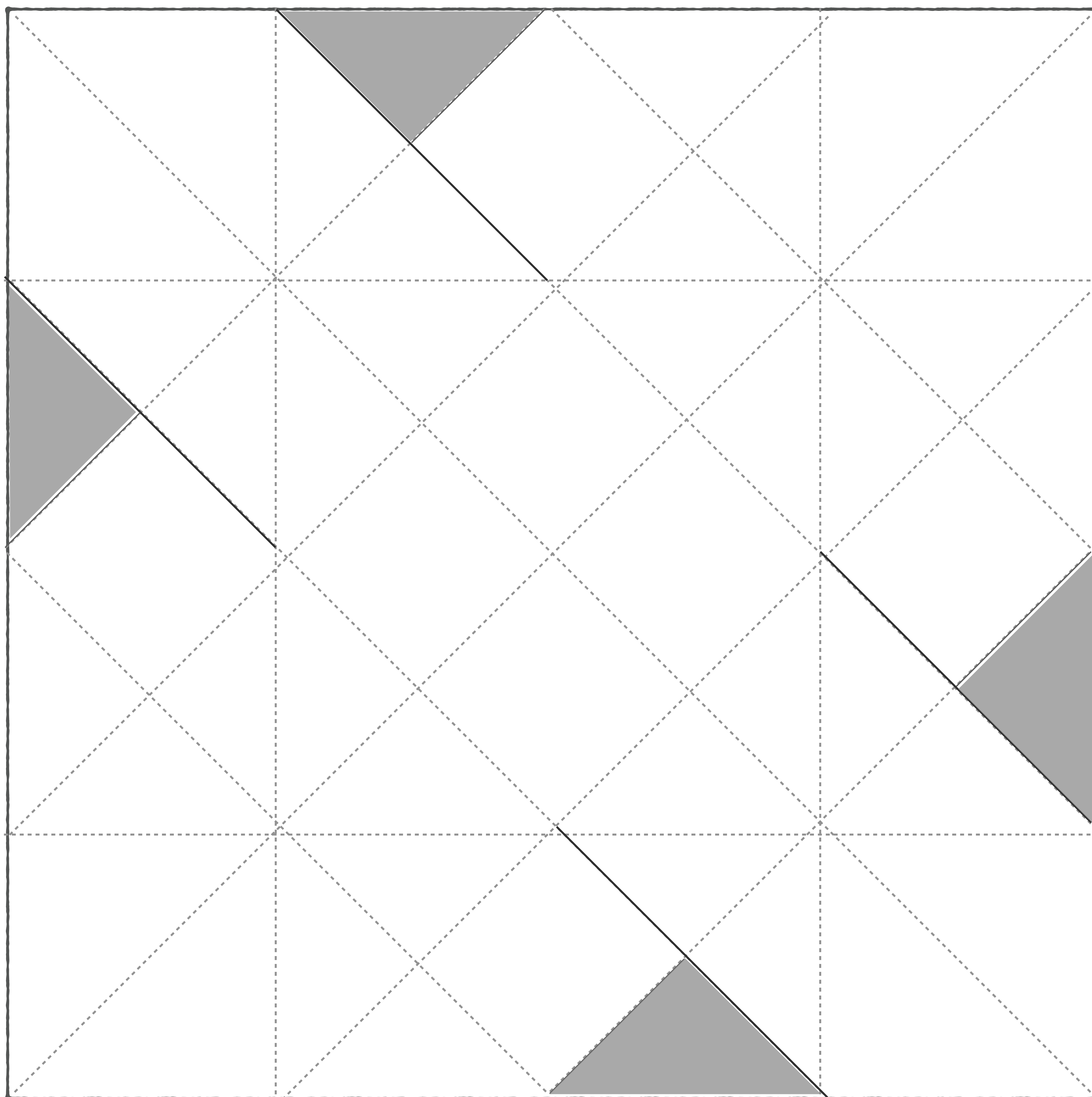

## *Box Template*

DIY Gift Boxes

1. Print on heavy card stock.
2. Cut out.
3. Decorate non-printed side.
4. Fold per instructions.
5. Snip on solid lines; discard shaded triangles.
6. Re-fold.
7. Fill!

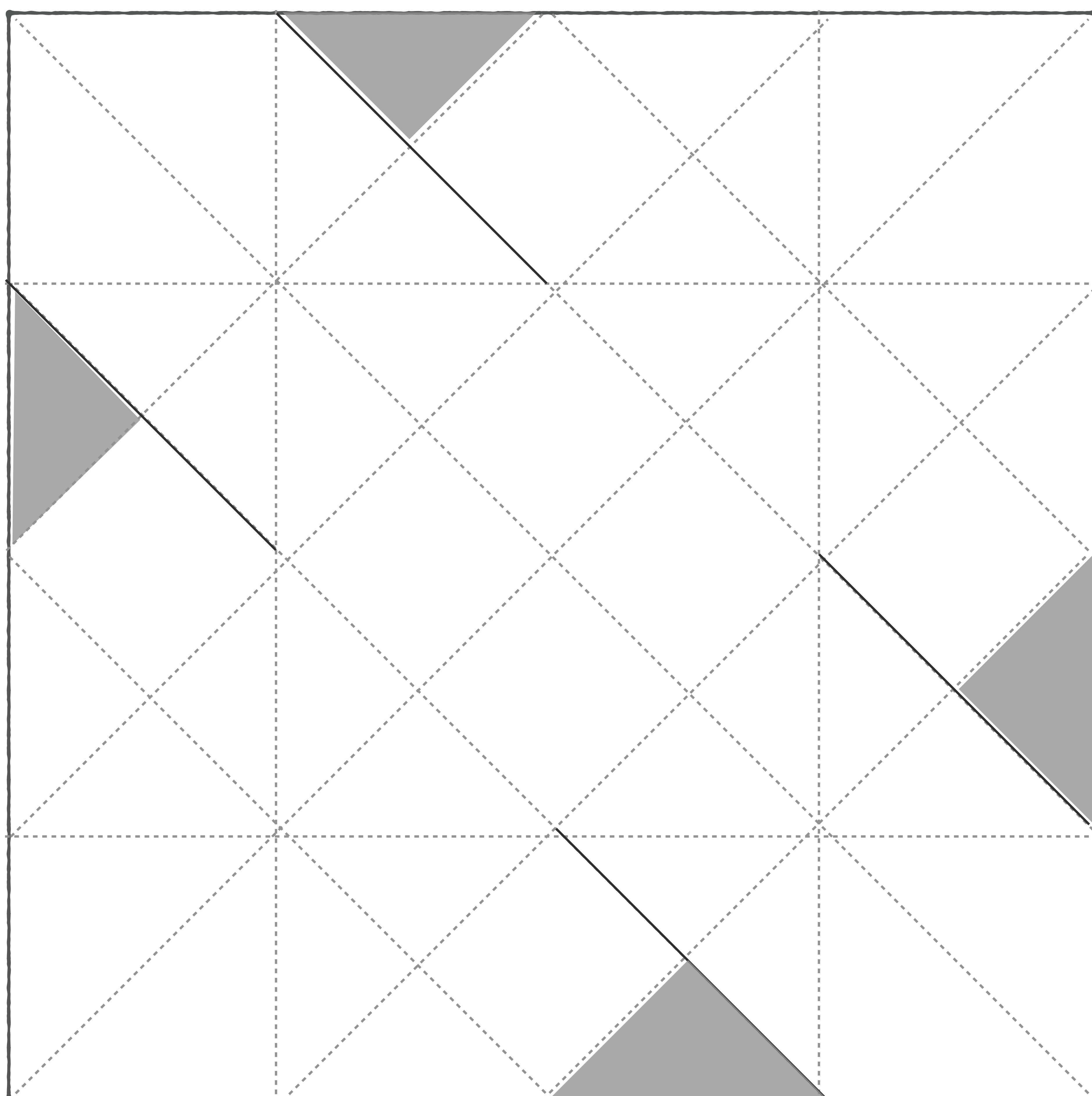

*bottom*

# Writer's Corner



Draw & Write

Draw some of your favorite winter things!

How many winter things can you list? Circle your favorites.

---

---

---

---

---

---

# Thank you for downloading the Printable Nature Journal!!

Find more creative crafts and activities at [rebeccagrabil.com](http://rebeccagrabil.com)!  
Plus, subscribe to my newsletter for updates on new printable packs, forthcoming books, and general inspiration!

## I love this! Where can I find more of your books?

I'm so glad you asked! I have all my books as well as printables and activities galore listed on my website, <https://www.rebeccagrabil.com>.

Three of my books are *Violet and the Woof* (HarperCollins), *A Year With Mama Earth* (Eerdmans), and *Halloween Good Night* (Atheneum).

## What else do you offer?

I've created oodles of resources to help you use literature in the classroom!

- \*Printable Packs
- \*Coloring Pages
- \*Crafts and Games
- \*Educational Resources
- \*Lesson Plans

But wait, there's more! I do school visits and, for those schools far from me, Skype visits!

## One last thing...

I would LOVE to hear from you! Please send me stories, artwork, letters at [rebeccawritesbooks@gmail.com](mailto:rebeccawritesbooks@gmail.com)



*Rebecca Grabil*

## The Fine Print

This packet is free to you for unlimited personal/classroom use.

You may NOT republish, repackage, resell, redistribute any of these pages in any way without my permission.

You MAY link to the product download page (not the file itself, please). Please contact me with any questions: [rebeccawritesbooks@gmail.com](mailto:rebeccawritesbooks@gmail.com)

©Rebecca Grabil 2019

*Rebecca Grabil*  
WRITER

Designed by Rebecca Grabil

## Permissions



Illustrations used with permission from Eerdmans Books for Young Readers



Illustrations used with permission from Atheneum Books for Young Readers



Clip art sourced from PublicDomainVectors.org and pixabay.com

HarperCollins Publishers



Illustrations used with permission from HarperCollins Katherine Tegen Books